

T-yhde

TCPU



Tuotekuvaus

Kokonaan tai yläosaltaan syvävedetty lähtökaulus PSU:hun rakennettu T-yhde.

Mitat

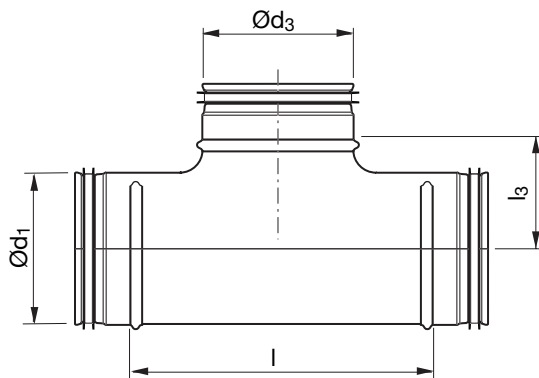

Ød ₁ nom	Ød ₃ nom	l mm	l ₃ mm	m kg
63	63	125	42	0,26
80	63	125	50	0,31
80	80	140	52	0,36
100	63	125	60	0,35
100	80	97	60	0,23
100	100	130	65	0,32
125	63	125	73	0,44
125	80	97	72	0,34
125	100	130	78	0,37
125	125	165	83	0,44
160	80	140	92	0,59
160	100	130	95	0,46
160	125	166	100	0,53
160	160	209	105	0,63
200	80	140	112	0,77
200	100	175	115	0,88
200	125	215	115	1,02
200	160	209	125	0,67
200	200	249	125	1,21
250	80	156	137	1,13
250	100	175	140	1,22
250	125	220	145	1,48
250	160	256	150	1,58
250	200	306	150	1,78
250	250	296	150	1,65
315	80	156	170	1,43
315	100	175	173	1,50
315	125	220	178	1,76
315	160	256	182	1,96
315	200	237	185	1,45
315	250	350	182	2,59
315	315	363	182	2,20

Tilausesimerkki

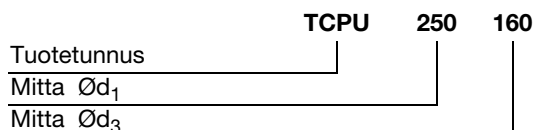

T-yhde

TCPU

	Ød ₁ nom	Ød ₃ nom	l mm	l ₃ mm	m kg
1	400	100	175	215	2,27
2	400	125	225	220	2,81
	400	160	266	225	3,02
	400	200	300	225	3,37
3	400	250	350	225	3,79
	400	315	415	225	4,42
	400	400	510	225	6,20
4	500	100	175	265	3,06
	500	125	225	270	3,35
	500	160	266	275	3,77
5	500	200	300	275	4,14
	500	250	350	275	4,68
	500	315	415	275	5,30
6	500	400	510	275	6,34
	500	500 *	552	290	8,27
7	630	100	175	330	4,03
	630	125	225	335	4,41
	630	160	266	340	4,99
8	630	200	300	340	5,35
	630	250	350	340	6,00
	630	315	415	340	6,77
9	630	400	510	340	7,69
	630	500 *	552	340	8,44
10	630	630 *	680	340	11,3

* Rakennettu jyrkkään PSU lähtökaulukseen.

T-haara ja lähtökaulus

TCPU, PSU

Tuloilma

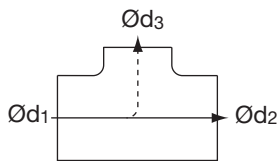
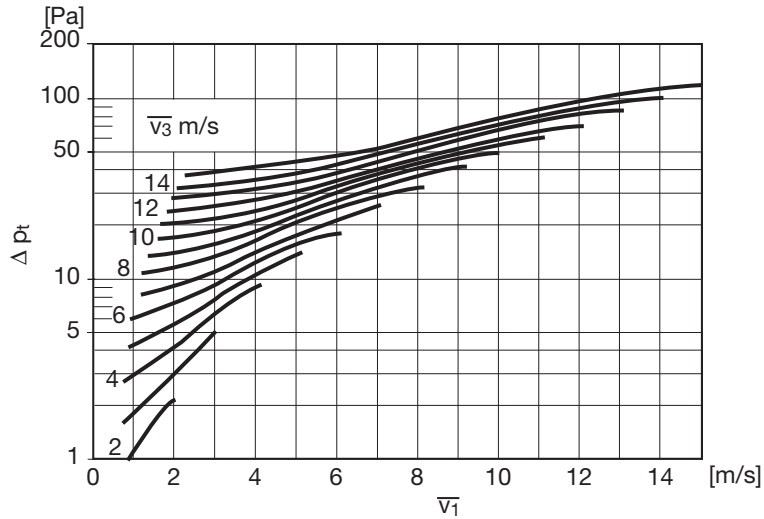
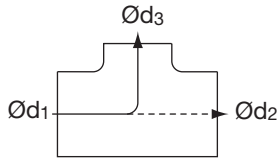

Taulukkoa voidaan käyttää myös supistukselle Ød₂.

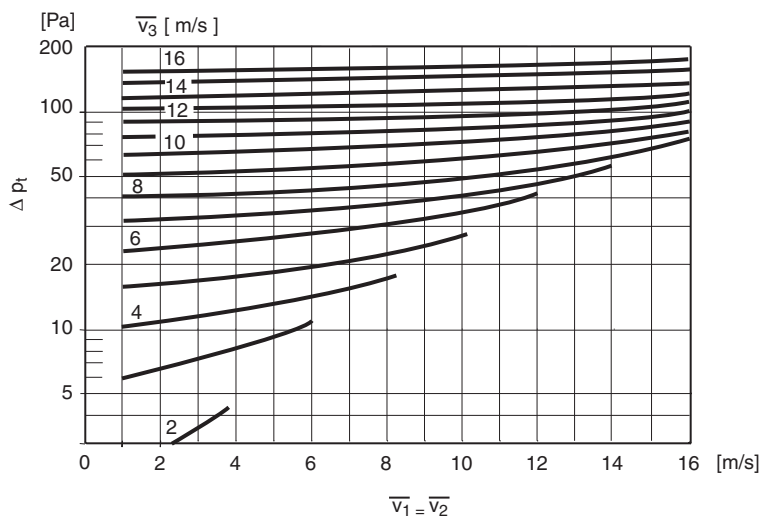
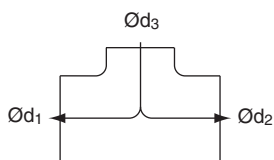
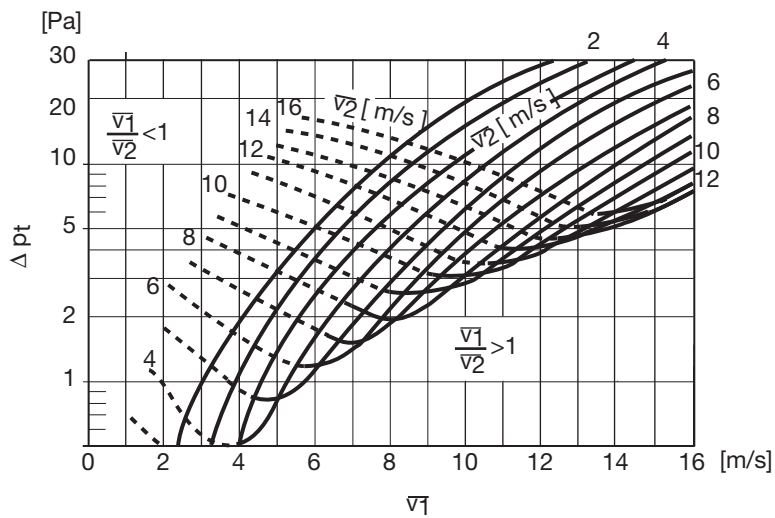

- 1
- 2
- 3
- 4
- 5
- 6
- 7
- 8
- 9
- 10
- 11
- 12
- 13
- 14
- 15
- 16
- 17
- 18

T-haara ja lähtökaulus

TCPU, PSU

Poistoilma

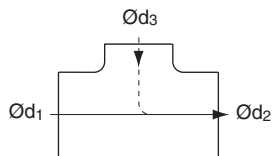
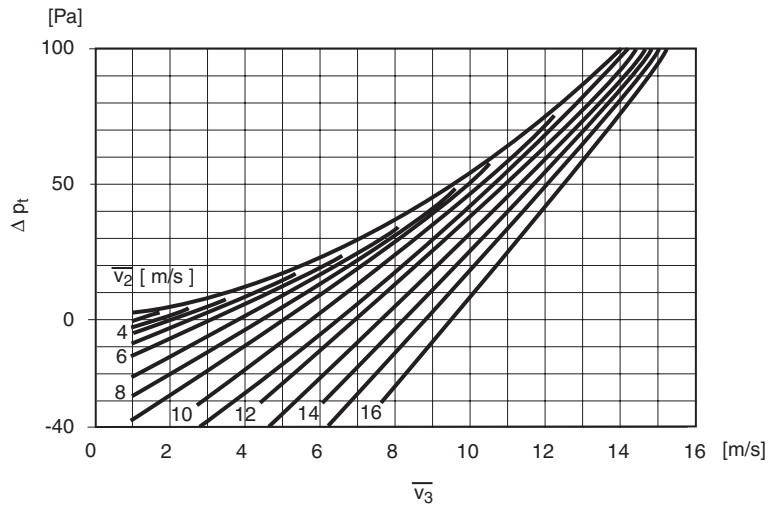
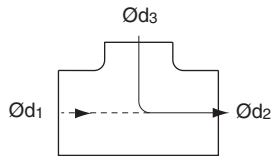

Taulukkoa voidaan käyttää myös supistukselle Ød_1 .

